

5 kHz - 2.5 GHz SLL FIBER OPTIC LINK

FEATURES

- Bandwidth 5 kHz to 2.5 GHz
- Small size
- Un-cooled DFB laser
- No external control circuits required
- Transimpedance amplifier in both transmitter and receiver
- Operational status monitor pins

APPLICATIONS

- Antenna remoting
- Local oscillator remoting
- Interfacility communication links

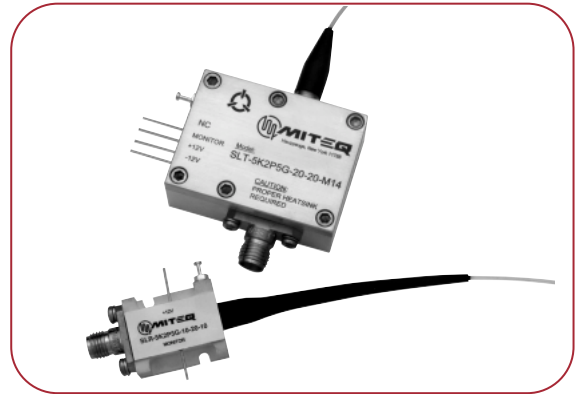

ELECTRICAL SPECIFICATIONS

PARAMETERS	CONDITION	UNITS	MIN.	TYP.	MAX.
Operating frequency*	3 dB bandwidth		5 kHz		2.5 GHz
Gain		dB	5	12	15
Noise figure		dB		18	20
Group delay	Peak-to-peak	ns		0.1	0.2
VSWR	Input/output				2:1
Phase noise	100 Hz offset	dBc	100		
Input power at 1 dB compression	Option A	dBm	-14		
Spurious-free dynamic range	1 Hz bandwidth	dB/Hz ^{2/3}	100		
Maximum input power	No damage	dBm			+10
Maximum output power	Saturated	dBm			+10
Impedance	Input/output	Ohms		50	
RF connectors	SMA female (male optional)				

NOTE: -30 dBm input power.

* Data measured from 10 kHz and above. Substrack bands also available.

OPTICAL PERFORMANCE SPECIFICATIONS

PARAMETERS	CONDITION	UNITS	MIN.	TYP.	MAX.
Fiber optic connectors	FC/APC (Other standard available)				
Fiber	Single mode fiber (9/125μm)				
Wavelength		nm	1540	1550	1560
Spectral width	FWHM	nm			0.1
Optical power in fiber	Reference only	mW	3	4	
Side mode suppression ratio		dB	30	40	

POWER REQUIREMENTS

PARAMETERS	CURRENT @ 25°C BASE PLATE	UNITS	MIN.	TYP.	MAX.
			(VDC)	(VDC)	(VDC)
Transmitter	100 mA	2	+11	+12	+20
	100 mA	1	-11	-12	-20
Receiver	100 mA	4	+11	+12	+20

TYPICAL TEST DATA

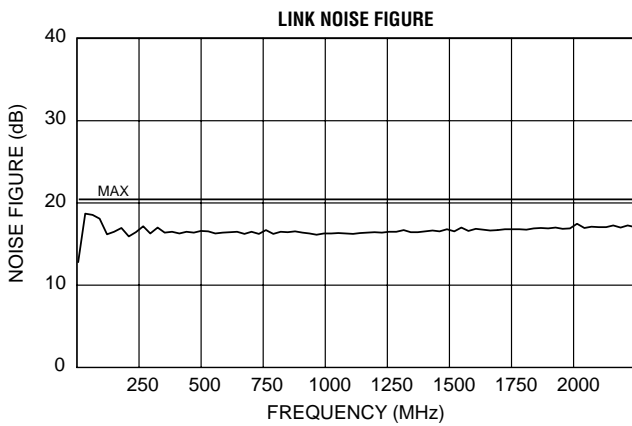
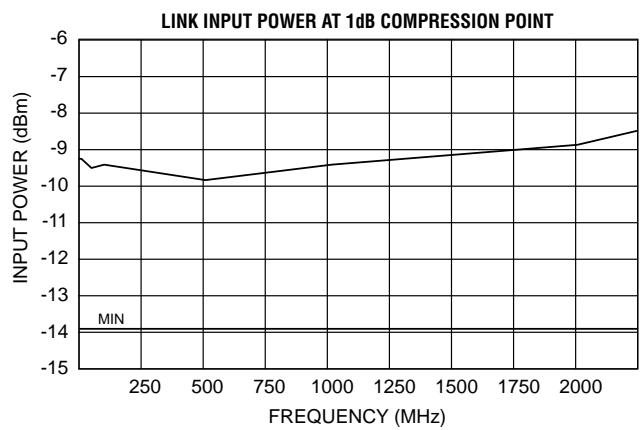
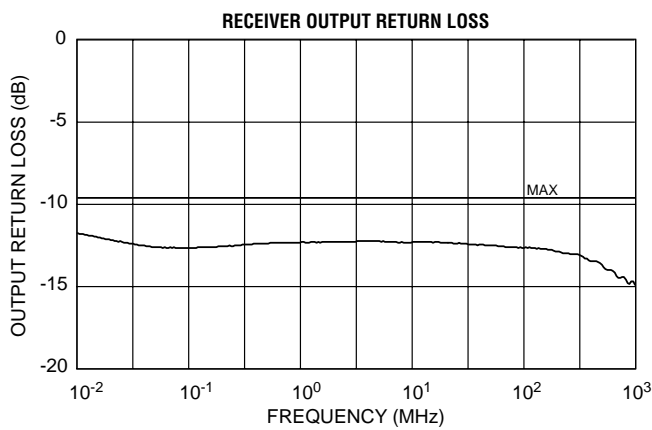
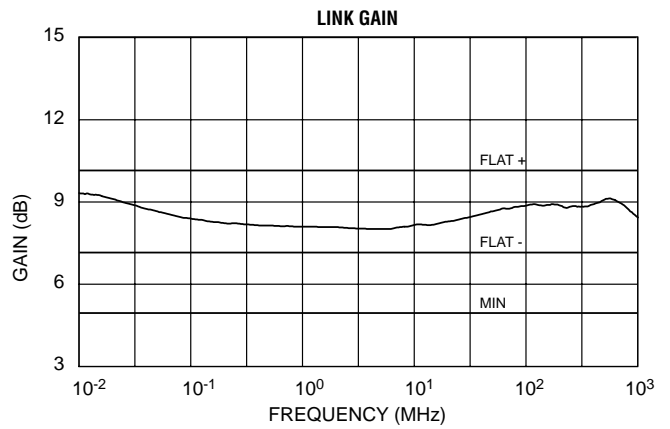
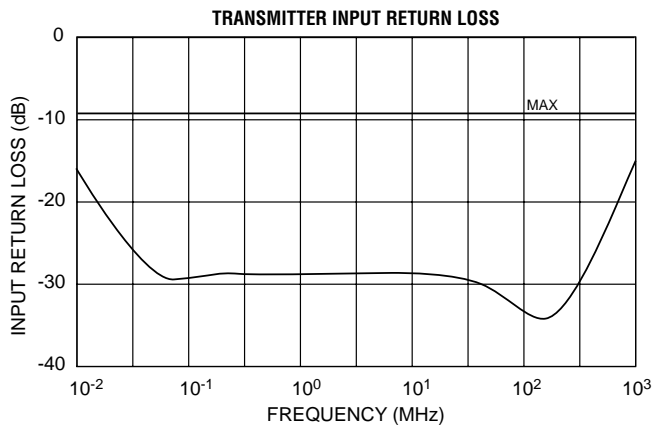

TYPICAL TEST DATA (CONT.)

**TRANSMITTER SPECTRUM
50 nM SPAN**

DFB Source Test (TrA)	Stop Band	1.55 nm	Peak Amplitude	9.86 dBm
Peak Wavelength	Center Offset	0.07 nm	Bandwidth	0.55 nm
Mode Offset	SMSR	44.69 dB	at:	-3.00 dB

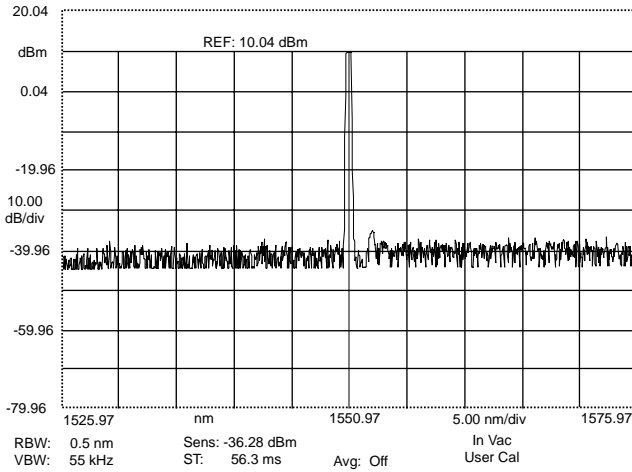

**TRANSMITTER SPECTRUM
5 nM SPAN**

DFB Source Test (TrA)	Stop Band	0.990 nm	Peak Amplitude	9.96 dBm
Peak Wavelength	Center Offset	-0.230 nm	Bandwidth	0.050 nm
Mode Offset	SMSR	46.53 dB	at:	-3.00 dB

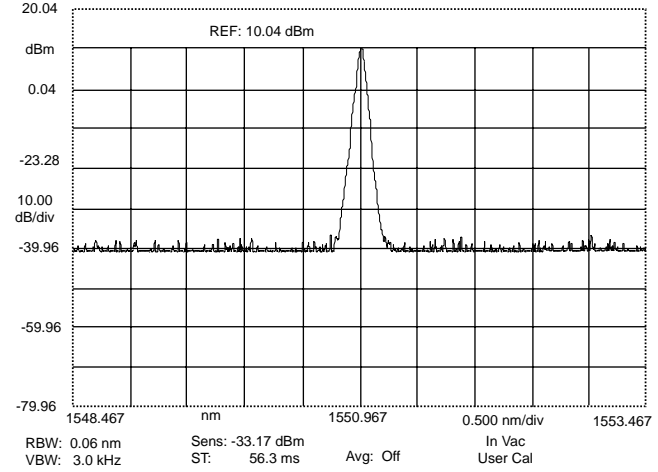

BLOCK DIAGRAM

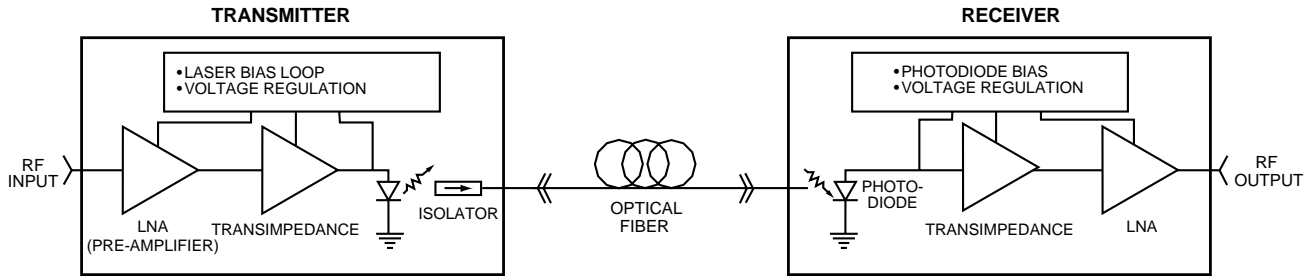

ORDERING INFORMATION

Transmitter..... Part number: SLT-5K2P5G-20-20-M14
 Receiver..... Part number: SLR-5K2P5G-10-20-10

ENVIRONMENTAL CONDITIONS

Operating temperature -20 to +70°C
 Storage temperature -40 to +85°C
 Humidity 95% relative humidity, noncondensing

TRANSMITTER OUTLINE DRAWING

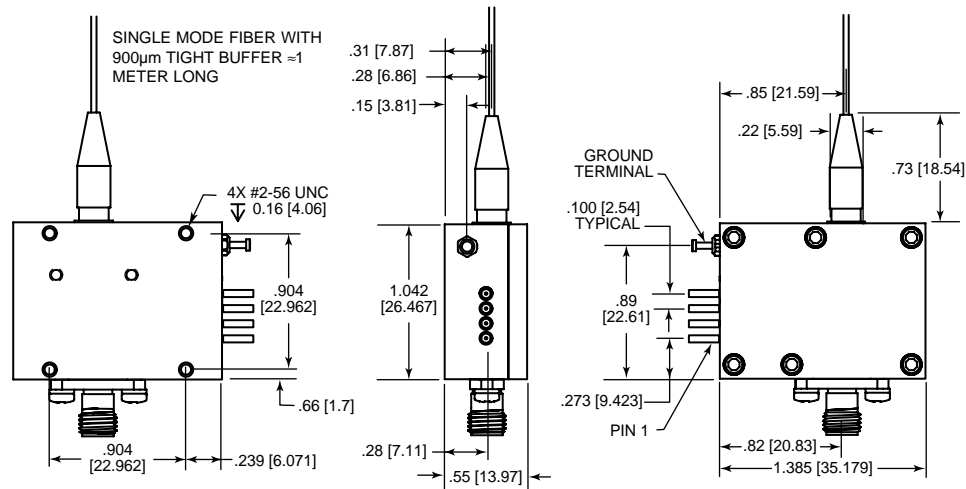

TRANSMITTER POWER SUPPLY

PIN	VOLTAGE	CURRENT (AMPS)	NOTES
1	-12	0.1	
2	+12	0.1	
3	PHOTOCURRENT MONITOR		REFER TO "OPERATIONAL STATUS"

TRANSMITTER OPERATIONAL STATUS

PIN	DESCRIPTION	NORMAL VOLTAGE	NOTES
3	OPTICAL POWER MONITOR	-2.5 V TO -1.5 V	0 VOLTS INDICATES NO LASER LIGHT

RF CONNECTOR: SMA (FEMALE STANDARD)
OPTICAL CONNECTOR: FC/APC STANDARD (OTHER STANDARDS AVAILABLE)
OPTICAL FIBER: 9/125 SINGLE MODE

RECEIVER OUTLINE DRAWING

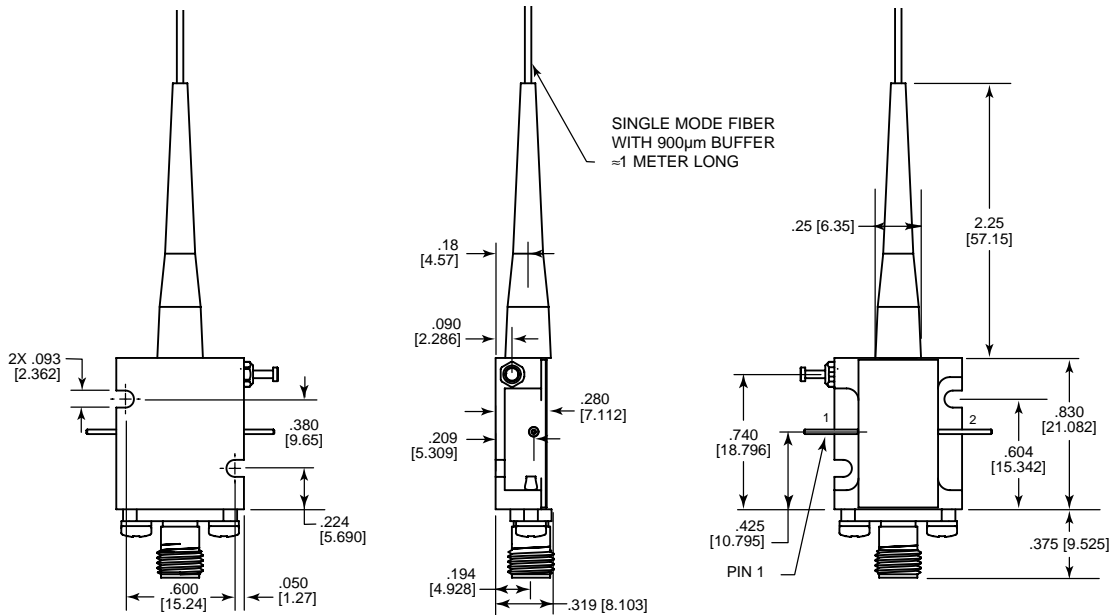

RECEIVER POWER SUPPLY

PIN	VOLTAGE	CURRENT (AMPS)	NOTES
1	PHOTOCURRENT MONITOR		REFER TO "OPERATIONAL STATUS"
2	+12	0.1	

RECEIVER OPERATIONAL STATUS

PIN	DESCRIPTION	NORMAL VOLTAGE	NOTES
1	OPTICAL CARRIER DETECT	> 1.0 UP TO +8	0 VOLTS INDICATES NO CARRIER PRESENT. VOLTAGE INCREASES APPROXIMATELY 1.3 V/mW WITH DETECTED OPTICAL POWER.

RF CONNECTOR: SMA (FEMALE STANDARD)
OPTICAL CONNECTOR: FC/APC STANDARD (OTHER STANDARDS AVAILABLE)
OPTICAL FIBER: 9/125 SINGLE MODE

NOTE: DIMENSIONS SHOWN IN BRACKETS [] ARE IN MILLIMETERS.

