

MITEQ AU-1464-400 AMPLIFIER

FREQUENCY (MHz)	MODEL NUMBER	GAIN (dB) (Min.)	VAR. (\pm dB) (Max.)	VSWR (Max.)	IMPED. IN/OUT (Ohms)	NOISE FIGURE (dB, Typ.)	P1 dB (dBm) (Typ.)	VOLTS	NOM. DC POWER (mA)	OUTLINE NO.
1-400	AU-1464-400	35	0.5	2.0:1	50/50	1.2	8	15	45	2

Gain (dB)

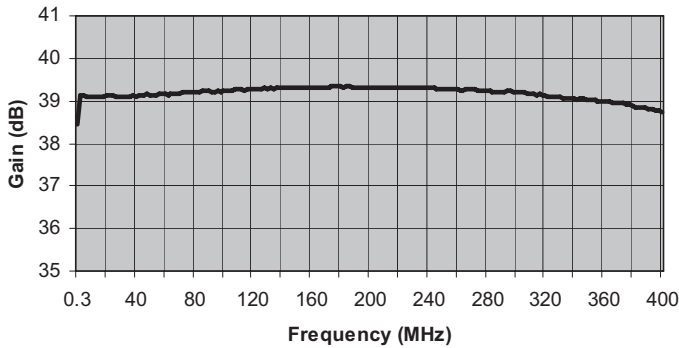

Output -1dB Gain Compression (+dBm)

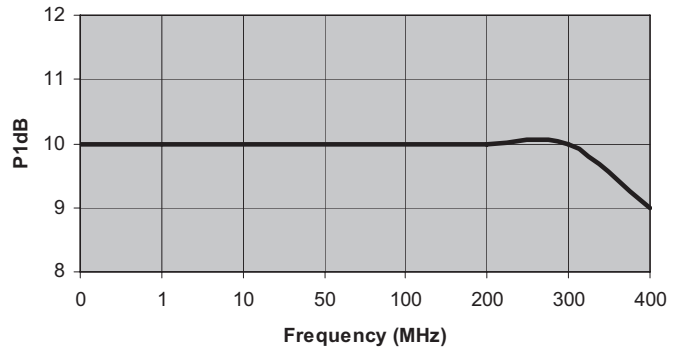

Input & Output Return Loss (dBRL)

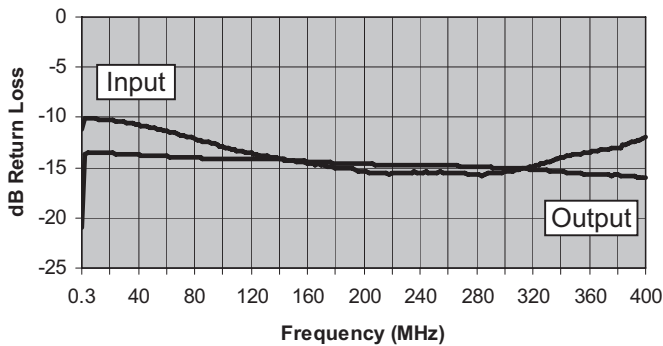

Noise Figure (dB)

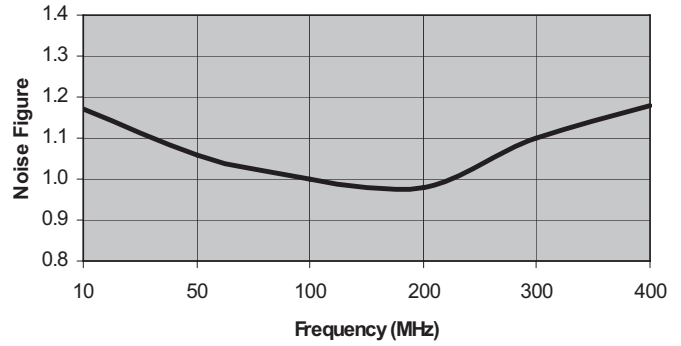

Reverse Isolation (dB)

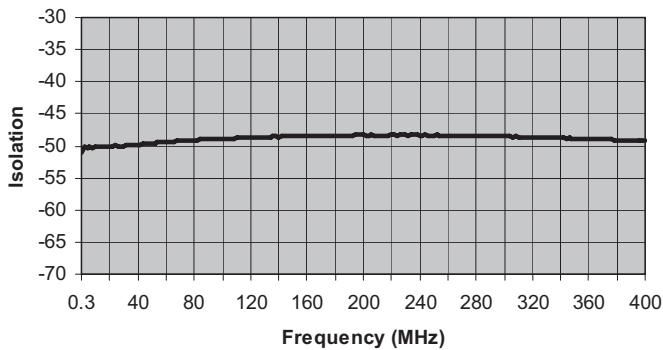

Low Frequency Gain Rolloff (dB)

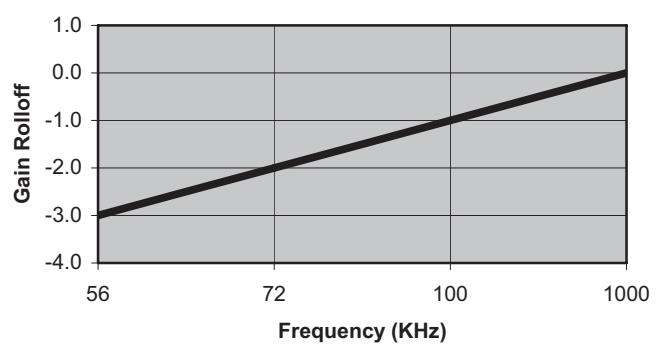

ISO 9001:2000 Certified • General Information • Warranty



100 Davids Drive, Hauppauge, NY 11788
 TEL.: (631) 439-9220 • FAX: (631) 436-7430
 e-mail: components@miteq.com • www.miteq.com

MITEQ AU-1464-400 AMPLIFIER

Freq. (MHz)	Gain (dB)
0.3	38.4
2	39.1
4	39.1
6	39.1
8	39.1
10	39.1
12	39.1
14	39.1
16	39.1
18	39.1
20	39.1
22	39.1
24	39.1
26	39.1
28	39.1
30	39.1
32	39.1
34	39.1
36	39.1
38	39.1
40	39.1
42	39.1
44	39.1
46	39.1
48	39.2
50	39.1
52	39.1
54	39.1
56	39.2
58	39.2
60	39.2
62	39.1
64	39.2
66	39.2
68	39.2
70	39.2
72	39.2
74	39.2
76	39.2
78	39.2
80	39.2
82	39.2
84	39.2
86	39.2
88	39.2
90	39.2
92	39.2
94	39.2
96	39.2
98	39.2
100	39.2
102	39.2
104	39.2
106	39.2
108	39.3
110	39.3
112	39.3
114	39.3

Freq. (MHz)	Gain (dB)
116	39.3
118	39.3
120	39.3
122	39.3
124	39.3
126	39.3
128	39.3
130	39.3
132	39.3
134	39.3
136	39.3
138	39.3
140	39.3
142	39.3
144	39.3
146	39.3
148	39.3
150	39.3
152	39.3
154	39.3
156	39.3
158	39.3
160	39.3
162	39.3
164	39.3
166	39.3
168	39.3
170	39.3
172	39.3
174	39.3
176	39.3
178	39.3
180	39.3
182	39.3
184	39.3
186	39.3
188	39.3
190	39.3
192	39.3
194	39.3
196	39.3
198	39.3
200	39.3
202	39.3
204	39.3
206	39.3
208	39.3
210	39.3
212	39.3
214	39.3
216	39.3
218	39.3
220	39.3
222	39.3
224	39.3
226	39.3
228	39.3
230	39.3

Freq. (MHz)	Gain (dB)
232	39.3
234	39.3
236	39.3
238	39.3
240	39.3
242	39.3
244	39.3
246	39.3
248	39.3
250	39.3
252	39.3
254	39.3
256	39.3
258	39.3
260	39.3
262	39.2
264	39.3
266	39.3
268	39.3
270	39.3
272	39.3
274	39.2
276	39.2
278	39.2
280	39.2
282	39.2
284	39.2
286	39.2
288	39.2
290	39.2
292	39.2
294	39.2
296	39.2
298	39.2
300	39.2
302	39.2
304	39.2
306	39.2
308	39.2
310	39.2
312	39.2
314	39.1
316	39.2
318	39.1
320	39.1
322	39.1
324	39.1
326	39.1
328	39.1
330	39.1
332	39.1
334	39.1
336	39.1
338	39.1
340	39.1
342	39.0
344	39.1
346	39.1

Freq. (MHz)	Gain (dB)
348	39.0
350	39.0
352	39.0
354	39.0
356	39.0
358	39.0
360	39.0
362	39.0
364	39.0
366	39.0
368	38.9
370	38.9
372	38.9
374	38.9
376	38.9
378	38.9
380	38.9
382	38.9
384	38.8
386	38.8
388	38.8
390	38.8
392	38.8
394	38.8
396	38.8
398	38.8
400	38.8



100 Davids Drive, Hauppauge, NY 11788
 TEL.: (631) 439-9220 • FAX: (631) 436-7430
 e-mail: components@miteq.com • www.miteq.com

MITEQ AU-1464-400 AMPLIFIER

Freq. (MHz)	Input VSWR (dBRL)	Input VSWR (dBRL)
0.3	-11	-21
2	-10	-14
4	-10	-14
6	-10	-14
8	-10	-14
10	-10	-14
12	-10	-14
14	-10	-14
16	-10	-14
18	-10	-14
20	-10	-14
22	-10	-14
24	-10	-14
26	-10	-14
28	-10	-14
30	-10	-14
32	-11	-14
34	-11	-14
36	-11	-14
38	-11	-14
40	-11	-14
42	-11	-14
44	-11	-14
46	-11	-14
48	-11	-14
50	-11	-14
52	-11	-14
54	-11	-14
56	-11	-14
58	-11	-14
60	-11	-14
62	-11	-14
64	-12	-14
66	-12	-14
68	-12	-14
70	-12	-14
72	-12	-14
74	-12	-14
76	-12	-14
78	-12	-14
80	-12	-14
82	-12	-14
84	-12	-14
86	-12	-14
88	-12	-14
90	-12	-14
92	-13	-14
94	-13	-14
96	-13	-14
98	-13	-14
100	-13	-14
102	-13	-14
104	-13	-14
106	-13	-14
108	-13	-14
110	-13	-14

Freq. (MHz)	Input VSWR (dBRL)	Input VSWR (dBRL)
0.3	-11	-21
112	-13	-14
114	-13	-14
116	-13	-14
118	-14	-14
120	-14	-14
122	-14	-14
124	-14	-14
126	-14	-14
128	-14	-14
130	-14	-14
132	-14	-14
134	-14	-14
136	-14	-14
138	-14	-14
140	-14	-14
142	-14	-14
144	-14	-14
146	-14	-14
148	-14	-14
150	-14	-14
152	-14	-14
154	-14	-14
156	-14	-14
158	-14	-14
160	-15	-14
162	-15	-14
164	-15	-14
166	-15	-14
168	-15	-14
170	-15	-14
172	-15	-14
174	-15	-14
176	-15	-15
178	-15	-15
180	-15	-15
182	-15	-15
184	-15	-15
186	-15	-15
188	-15	-15
190	-15	-15
192	-15	-15
194	-15	-15
196	-15	-15
198	-15	-15
200	-15	-15
202	-15	-15
204	-15	-15
206	-15	-15
208	-16	-15
210	-16	-15
212	-16	-15
214	-16	-15
216	-16	-15
218	-16	-15
220	-16	-15
222	-16	-15

Freq. (MHz)	Input VSWR (dBRL)	Input VSWR (dBRL)
0.3	-11	-21
224	-16	-15
226	-16	-15
228	-16	-15
230	-15	-15
232	-16	-15
234	-15	-15
236	-15	-15
238	-16	-15
240	-15	-15
242	-15	-15
244	-15	-15
246	-16	-15
248	-16	-15
250	-16	-15
252	-15	-15
254	-15	-15
256	-15	-15
258	-15	-15
260	-15	-15
262	-15	-15
264	-15	-15
266	-16	-15
268	-16	-15
270	-16	-15
272	-16	-15
274	-16	-15
276	-16	-15
278	-16	-15
280	-16	-15
282	-16	-15
284	-16	-15
286	-16	-15
288	-16	-15
290	-15	-15
292	-16	-15
294	-15	-15
296	-16	-15
298	-15	-15
300	-15	-15
302	-15	-15
304	-15	-15
306	-15	-15
308	-15	-15
310	-15	-15
312	-15	-15
314	-15	-15
316	-15	-15
318	-15	-15
320	-15	-15
322	-15	-15
324	-15	-15
326	-15	-15
328	-15	-15
330	-14	-15
332	-14	-15
334	-14	-15

Freq. (MHz)	Input VSWR (dBRL)	Input VSWR (dBRL)
0.3	-11	-21
336	-14	-15
338	-14	-15
340	-14	-15
342	-14	-15
344	-14	-15
346	-14	-16
348	-14	-16
350	-14	-16
352	-14	-16
354	-14	-16
356	-14	-16
358	-14	-16
360	-14	-16
362	-13	-16
364	-13	-16
366	-13	-16
368	-13	-16
370	-13	-16
372	-13	-16
374	-13	-16
376	-13	-16
378	-13	-16
380	-13	-16
382	-13	-16
384	-13	-16
386	-13	-16
388	-13	-16
390	-12	-16
392	-12	-16
394	-12	-16
396	-12	-16
398	-12	-16
400	-12	-16



100 Davids Drive, Hauppauge, NY 11788
 TEL.: (631) 439-9220 • FAX: (631) 436-7430
 e-mail: components@miteq.com • www.miteq.com

MITEQ AU-1464-400 AMPLIFIER

Freq. (MHz)	Input VSWR (dBRL)	Input VSWR (dBRL)
0.3	-11	-21
2	-10	-14
4	-10	-14
6	-10	-14
8	-10	-14
10	-10	-14
12	-10	-14
14	-10	-14
16	-10	-14
18	-10	-14
20	-10	-14
22	-10	-14
24	-10	-14
26	-10	-14
28	-10	-14
30	-10	-14
32	-11	-14
34	-11	-14
36	-11	-14
38	-11	-14
40	-11	-14
42	-11	-14
44	-11	-14
46	-11	-14
48	-11	-14
50	-11	-14
52	-11	-14
54	-11	-14
56	-11	-14
58	-11	-14
60	-11	-14
62	-11	-14
64	-12	-14
66	-12	-14
68	-12	-14
70	-12	-14
72	-12	-14
74	-12	-14
76	-12	-14
78	-12	-14
80	-12	-14
82	-12	-14
84	-12	-14
86	-12	-14
88	-12	-14
90	-12	-14
92	-13	-14
94	-13	-14
96	-13	-14
98	-13	-14
100	-13	-14
102	-13	-14
104	-13	-14
106	-13	-14
108	-13	-14
110	-13	-14

Freq. (MHz)	Input VSWR (dBRL)	Input VSWR (dBRL)
0.3	-11	-21
112	-13	-14
114	-13	-14
116	-13	-14
118	-14	-14
120	-14	-14
122	-14	-14
124	-14	-14
126	-14	-14
128	-14	-14
130	-14	-14
132	-14	-14
134	-14	-14
136	-14	-14
138	-14	-14
140	-14	-14
142	-14	-14
144	-14	-14
146	-14	-14
148	-14	-14
150	-14	-14
152	-14	-14
154	-14	-14
156	-14	-14
158	-14	-14
160	-15	-14
162	-15	-14
164	-15	-14
166	-15	-14
168	-15	-14
170	-15	-14
172	-15	-14
174	-15	-14
176	-15	-15
178	-15	-15
180	-15	-15
182	-15	-15
184	-15	-15
186	-15	-15
188	-15	-15
190	-15	-15
192	-15	-15
194	-15	-15
196	-15	-15
198	-15	-15
200	-15	-15
202	-15	-15
204	-15	-15
206	-15	-15
208	-16	-15
210	-16	-15
212	-16	-15
214	-16	-15
216	-16	-15
218	-16	-15
220	-16	-15
222	-16	-15

Freq. (MHz)	Input VSWR (dBRL)	Input VSWR (dBRL)
0.3	-11	-21
224	-16	-15
226	-16	-15
228	-16	-15
230	-15	-15
232	-16	-15
234	-15	-15
236	-15	-15
238	-16	-15
240	-15	-15
242	-15	-15
244	-15	-15
246	-16	-15
248	-16	-15
250	-16	-15
252	-15	-15
254	-15	-15
256	-15	-15
258	-15	-15
260	-15	-15
262	-15	-15
264	-15	-15
266	-16	-15
268	-16	-15
270	-16	-15
272	-16	-15
274	-16	-15
276	-16	-15
278	-16	-15
280	-16	-15
282	-16	-15
284	-16	-15
286	-16	-15
288	-16	-15
290	-15	-15
292	-16	-15
294	-15	-15
296	-16	-15
298	-15	-15
300	-15	-15
302	-15	-15
304	-15	-15
306	-15	-15
308	-15	-15
310	-15	-15
312	-15	-15
314	-15	-15
316	-15	-15
318	-15	-15
320	-15	-15
322	-15	-15
324	-15	-15
326	-15	-15
328	-15	-15
330	-14	-15
332	-14	-15
334	-14	-15

Freq. (MHz)	Input VSWR (dBRL)	Input VSWR (dBRL)
0.3	-11	-21
336	-14	-15
338	-14	-15
340	-14	-15
342	-14	-15
344	-14	-15
346	-14	-16
348	-14	-16
350	-14	-16
352	-14	-16
354	-14	-16
356	-14	-16
358	-14	-16
360	-14	-16
362	-13	-16
364	-13	-16
366	-13	-16
368	-13	-16
370	-13	-16
372	-13	-16
374	-13	-16
376	-13	-16
378	-13	-16
380	-13	-16
382	-13	-16
384	-13	-16
386	-13	-16
388	-13	-16
390	-12	-16
392	-12	-16
394	-12	-16
396	-12	-16
398	-12	-16
400	-12	-16



MITEQ AU-1464-400 AMPLIFIER

OUTLINE	DIM A	DIM B	OUNCES
2	1.92 [48.77]	1.72 [43.69]	2.2

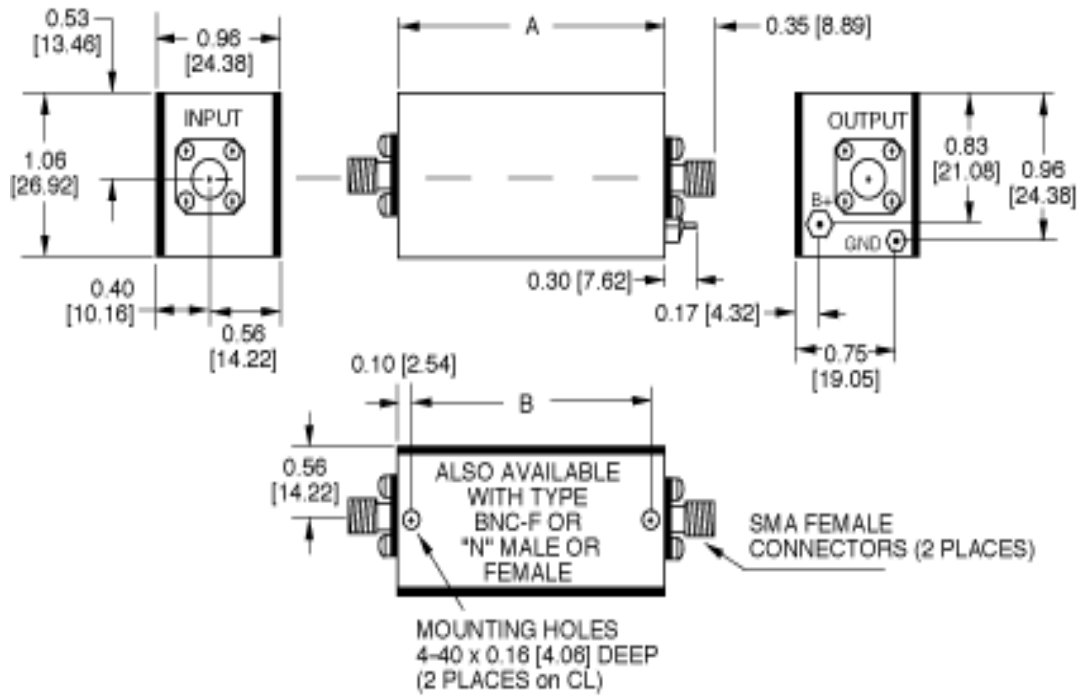

NOTE: DIMENSIONS ARE IN INCHES [MILLIMETERS].



100 Davids Drive, Hauppauge, NY 11788
 TEL.: (631) 439-9220 • FAX: (631) 436-7430
 e-mail: components@miteq.com • www.miteq.com

OPTIONS FOR BIPOLAR AMPLIFIERS

INPUT BIAS TEE

Add Suffix “-F”

Used to inject bias signal to photo diode or other type of device. Check for availability on your model before ordering. Available on most units operating above 1 MHz. Please contact MITEQ with your custom requirements.

BIAS THROUGH THE OUTPUT CONNECTOR

Add Suffix “-1306/E” or “-1306/D”

Used to supply operating power when the amplifier is remotely located while eliminating the need to run a separate DC line. Specify whether existing power pin should be “Enabled” or “Disabled.” To order, add -1306/E or -1306/D after model number. Example: AU-2A-0150-1306/E will have existing +15 V pin enabled so that it can be used as a test point. Use caution with this option since any voltage applied here will also be present on the RF output center pin. Available on most units operating above 1 MHz.

BIAS THROUGH THE OUTPUT CONNECTOR WITH DC FEEDTHROUGH TO RF INPUT

Add Suffix “-1334/E” or “-1334/D”

Used to supply operating power when the amplifier is remotely located and eliminates the need to run a separate DC line. This DC voltage is then internally fed to the RF input to power a remote LNA or other low power equipment. Maximum current of external load will vary with model type. Available on most units operating above 1 MHz. Please contact factory prior to ordering.

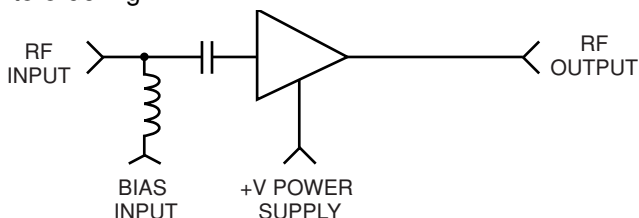

Specify whether existing power pin should be “Enabled” or “Disabled”. To order, add “-1334/E” or “-1334/D”

after model number. Example: AU-2A-0150-1334/E will have existing +15 V pin enabled so that it can be used as a test point. Use caution with this option since any voltage applied here will also be present on both the RF output and input center pins.

TYPE N OR BNC CONNECTORS

Add Suffix “-N” or “-BNC”

Type N-female and type BNC-female are available for all outlines 1 through 5, 12, 13 and 15 amplifiers. Add connector type after model number. Examples: AU-2A-0150-N; AU-2A-0150-BNC. Type N-male and mixed connector types are also available on request. Please call MITEQ with your specific requirements.

INPUT INTERNAL LIMITER

Add Suffix “-1103”

Available on models up to 500 MHz. Will protect the input stage from CW signals as high as +30 dBm. To order, add “-1103” after model number. Example: AU-2A-0150-1103. Options are available for protection against short duration pulses up to 50 W.

AC POWER SUPPLY (100 to 240 VAC, 47 - 440 Hz). Add Suffix “-1179”

Available as an add-on to most models using outlines 1 through 5 and 15. Includes 6-foot line cord with standard US line plug, internal fuse, on/off switch and LED indicator light. Amplifier is permanently mounted to power supply. To order, add “-1179” after model number. Example: AU-2A-0150-1179. Refer to outline 12 for dimensions.

AC POWER SUPPLY (Wall plug-in unit) Part Number “205531-19”

A low cost alternate to option “-1179”, the wall plug-in unit is a small switching power supply capable of delivering 1 amp at 15 volts.

AC POWER SUPPLY WITH SMC CONNECTORS (Wall plug-in unit) Part Number “-1179SC”

Same as above except has mating SMC connectors on amplifier DC input and power supply DC output. Available for outlines 1 through 10, 13 and 15.

ADDITIONAL OPTIONS AVAILABLE

OPTION	SUFFIX
Gain Window	-GW
Phase Match	-PM
Amplitude Match	-AM
Gain Control	-GC



GENERAL INFORMATION

PRICING AND TERMS

A quotation on any item in the catalog is available by contacting the factory. All quotations, unless otherwise noted, are valid for 60 days from the date of issue, F.O.B. (FCA) Hauppauge, NY 11788. Pricing does not include customer or government source inspection unless otherwise noted. On international orders, an irrevocable letter of credit may be required. MITEQ accepts these credit cards:

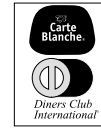

QUANTITY DISCOUNTS

A quantity discount is generally available on most catalog items. Due to the wide variety of devices in the catalog, it is not possible to provide a standard discount schedule. When quantities are involved, please contact the factory and the appropriate information will be provided.

SOURCE INSPECTION

Government / customer source inspection is available on any item upon receipt of the complete written confirmation of purchase order items, including the prime government contract number. Source inspection with respect to some products increases the unit price and extends delivery because of duplicate standard final inspection and testing. It is recommended wherever possible that a Certificate of Compliance be substituted for source inspection to minimize price and delivery delays.

SHIPPING INFORMATION

Unless instructed otherwise by the customer, we will ship UPS in the U.S. F.O.B. (FCA) Hauppauge. Air freight will be used as the primary international means of shipment. Please indicate at time of purchase what method of shipment you require.

RETURNED MATERIAL

When returning material for repair or replacement, please ensure that there is complete information included with the shipment, giving a detailed description of the reason for its return, the date and purchase order on which it was obtained, and the exact address to which the material is to be reshipped. All returns must arrive freight, postage, duties and handling prepaid.

REPAIR COSTS

Warranty repairs will be made at no cost to the customer. Units out of warranty, or those which have been mishandled, will require approval by the customer for the charges involved before the repairs can be accomplished. We will provide an estimate for the cost of the repair, which can be applied to the repair, if approval is granted. For those items that are deemed beyond repair, or where the customer may decide not to repair the unit, an evaluation fee and handling charge will be applicable.

APPLICATION ENGINEERING

We maintain a large support staff of engineers who are experts in specific areas of microwave technology. Each has an engineering background that combines both a formal engineering education with training and experience in product design. As further technical support, we make available the services of our engineering and scientific staff, who may be consulted on more advanced circuit designs or application problems.

DRAWINGS AND SPECIFICATIONS

The material presented in this catalog was current at the time of publication. MITEQ Inc.'s continuing product improvement program makes it necessary to reserve the right to change our mechanical and electrical specifications without notice. If either of these parameters is critical, please contact the factory to verify that the information is current.

ADDITIONAL INFORMATION

WARRANTY

ISO 9001:2000 Certified



MITEQ FEDERAL SUPPLY CODE

Our Federal Supply Code is: 33592



100 Davids Drive, Hauppauge, NY 11788
TEL.: (631) 439-9220 • FAX: (631) 436-7430
e-mail: components@miteq.com • www.miteq.com