

MITEQ AM-1604 SERIES AMPLIFIER

FREQUENCY (MHz)	MODEL NUMBER	GAIN (dB) (Min.)	VAR. (±dB) (Max.)	VSWR (Max.)	IMPED. IN/OUT (Ohms)	NOISE FIGURE (dB, Typ.)	P1 dB (dBm) (Typ.)	VOLTS	NOM. DC POWER (mA)	OUTLINE NO.
5-1000	AM-1604-1000	32	0.75	2.0:1	50/50	3.5	19	15	175	3
5-2000	AM-1604-2000	32	1	2.0:1	50/50	3.5	18	15	175	3
5-3000	AM-1604-3000	31	2.5	2.0:1	50/50	3.8	17	15	175	3

Gain (dB)

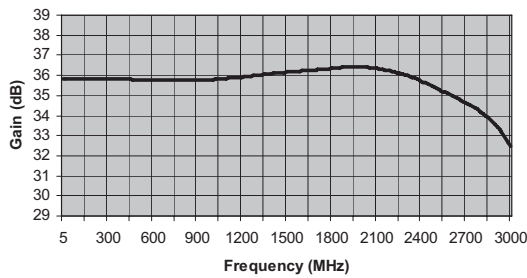

Output Third Order Intercept Point (+dBm)

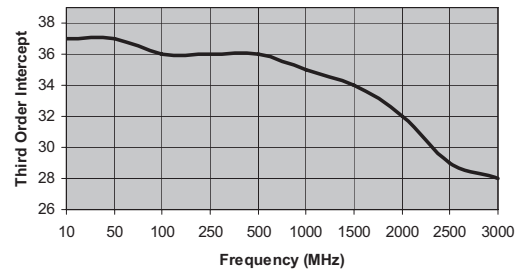

Input & Output Return Loss (dBRL)

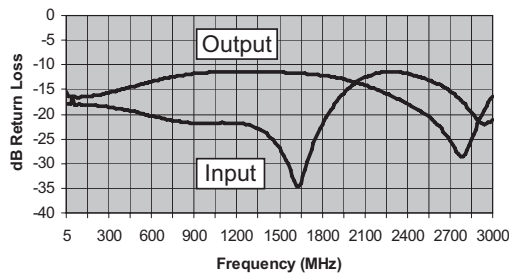

Noise Figure (dB)

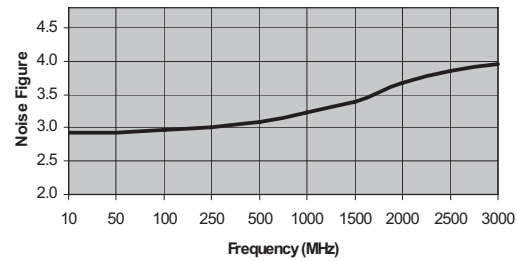

Reverse Isolation (dB)

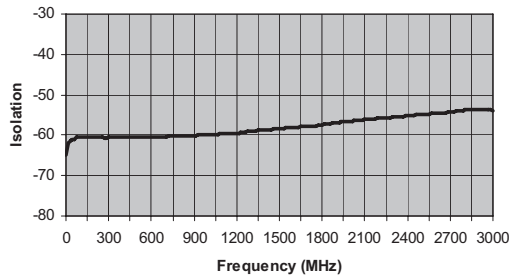

Low Frequency Gain Rolloff (dB)

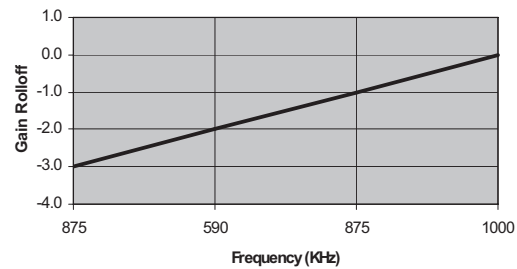

Output -1dB Gain Compression (+dBm)

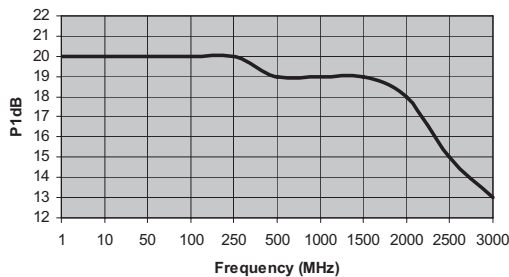

ISO 9001:2000 Certified • General Information • Warranty



100 Davids Drive, Hauppauge, NY 11788
 TEL.: (631) 439-9220 • FAX: (631) 436-7430
 e-mail: components@miteq.com • www.miteq.com

MITEQ AM-1604 SERIES AMPLIFIER

Freq. (MHz)	Gain (dB)
5	35.8
15	35.8
30	35.8
45	35.8
60	35.8
75	35.8
90	35.8
105	35.8
120	35.8
135	35.8
150	35.8
165	35.8
180	35.8
195	35.8
210	35.8
225	35.8
240	35.8
255	35.8
270	35.8
285	35.8
300	35.8
315	35.8
330	35.8
345	35.8
360	35.8
375	35.8
390	35.8
405	35.8
420	35.8
435	35.8
450	35.8
465	35.8
480	35.8
495	35.8
510	35.8
525	35.8
540	35.8
555	35.8
570	35.8
585	35.8
600	35.8
615	35.8
630	35.8
645	35.8
660	35.8
675	35.8
690	35.8
705	35.8
720	35.8
735	35.8
750	35.8
765	35.8
780	35.8
795	35.8
810	35.8
825	35.8
840	35.8

Freq. (MHz)	Gain (dB)
855	35.8
870	35.8
885	35.8
900	35.8
915	35.8
930	35.8
945	35.8
960	35.8
975	35.8
990	35.8
1005	35.8
1020	35.8
1035	35.8
1050	35.8
1065	35.8
1080	35.8
1095	35.9
1110	35.9
1125	35.9
1140	35.9
1155	35.9
1170	35.9
1185	35.9
1200	35.9
1215	35.9
1230	35.9
1245	35.9
1260	36.0
1275	36.0
1290	36.0
1305	36.0
1320	36.0
1335	36.0
1350	36.1
1365	36.1
1380	36.1
1395	36.1
1410	36.1
1425	36.1
1440	36.1
1455	36.1
1470	36.1
1485	36.1
1500	36.2
1515	36.2
1530	36.2
1545	36.2
1560	36.2
1575	36.2
1590	36.2
1605	36.2
1620	36.2
1635	36.2
1650	36.2
1665	36.3
1680	36.3
1695	36.3

Freq. (MHz)	Gain (dB)
1710	36.3
1725	36.3
1740	36.3
1755	36.3
1770	36.3
1785	36.3
1800	36.3
1815	36.4
1830	36.4
1845	36.4
1860	36.4
1875	36.4
1890	36.4
1905	36.4
1920	36.4
1935	36.4
1950	36.4
1965	36.4
1980	36.4
1995	36.4
2010	36.4
2025	36.4
2040	36.4
2055	36.4
2070	36.4
2085	36.4
2100	36.3
2115	36.3
2130	36.3
2145	36.3
2160	36.3
2175	36.2
2190	36.2
2205	36.2
2220	36.2
2235	36.1
2250	36.1
2265	36.1
2280	36.1
2295	36.0
2310	36.0
2325	35.9
2340	35.9
2355	35.9
2370	35.8
2385	35.8
2400	35.7
2415	35.7
2430	35.6
2445	35.6
2460	35.5
2475	35.5
2490	35.4
2505	35.4
2520	35.3
2535	35.3
2550	35.2

Freq. (MHz)	Gain (dB)
2565	35.1
2580	35.1
2595	35.0
2610	35.0
2625	34.9
2640	34.9
2655	34.8
2670	34.7
2685	34.7
2700	34.6
2715	34.6
2730	34.5
2745	34.4
2760	34.4
2775	34.3
2790	34.2
2805	34.2
2820	34.1
2835	34.0
2850	33.9
2865	33.8
2880	33.7
2895	33.6
2910	33.5
2925	33.3
2940	33.2
2955	33.0
2970	32.9
2985	32.7
3000	32.5



100 Davids Drive, Hauppauge, NY 11788
TEL.: (631) 439-9220 • FAX: (631) 436-7430
e-mail: components@miteq.com • www.miteq.com

MITEQ AM-1604 SERIES AMPLIFIER

Freq. (MHz)	Input VSWR (dBRL)	Output VSWR (dBRL)
5	-18	-15
15	-18	-16
30	-18	-16
45	-17	-16
60	-18	-16
75	-18	-17
90	-18	-17
105	-18	-17
120	-18	-16
135	-18	-16
150	-18	-16
165	-18	-16
180	-18	-16
195	-18	-16
210	-18	-16
225	-18	-16
240	-18	-16
255	-18	-16
270	-18	-16
285	-18	-16
300	-19	-16
315	-19	-16
330	-19	-15
345	-19	-15
360	-19	-15
375	-19	-15
390	-19	-15
405	-19	-15
420	-19	-15
435	-19	-15
450	-19	-15
465	-19	-14
480	-19	-14
495	-20	-14
510	-20	-14
525	-20	-14
540	-20	-14
555	-20	-14
570	-20	-14
585	-20	-13
600	-20	-13
615	-20	-13
630	-21	-13
645	-21	-13
660	-21	-13
675	-21	-13
690	-21	-13
705	-21	-13
720	-21	-13
735	-21	-12
750	-21	-12
765	-21	-12
780	-21	-12
795	-21	-12
810	-22	-12
825	-22	-12
840	-22	-12
855	-22	-12
870	-22	-12
885	-22	-12
900	-22	-12
915	-22	-12
930	-22	-12

Freq. (MHz)	Input VSWR (dBRL)	Output VSWR (dBRL)
945	-22	-12
960	-22	-12
975	-22	-12
990	-22	-12
1005	-22	-12
1020	-22	-12
1035	-22	-12
1050	-22	-11
1065	-22	-11
1080	-22	-11
1095	-22	-11
1110	-22	-11
1125	-22	-11
1140	-22	-11
1155	-22	-11
1170	-22	-11
1185	-22	-11
1200	-22	-11
1215	-22	-11
1230	-22	-11
1245	-22	-11
1260	-22	-11
1275	-22	-11
1290	-22	-11
1305	-22	-11
1320	-23	-11
1335	-23	-11
1350	-23	-11
1365	-23	-11
1380	-23	-11
1395	-24	-11
1410	-24	-11
1425	-24	-11
1440	-25	-11
1455	-25	-11
1470	-26	-11
1485	-26	-11
1500	-27	-12
1515	-28	-12
1530	-28	-12
1545	-29	-12
1560	-30	-12
1575	-31	-12
1590	-32	-12
1605	-34	-12
1620	-35	-12
1635	-35	-12
1650	-34	-12
1665	-33	-12
1680	-31	-12
1695	-30	-12
1710	-28	-12
1725	-27	-12
1740	-26	-12
1755	-25	-12
1770	-24	-12
1785	-23	-12
1800	-22	-12
1815	-21	-12
1830	-21	-12
1845	-20	-12
1860	-19	-12
1875	-19	-12

Freq. (MHz)	Input VSWR (dBRL)	Output VSWR (dBRL)
1890	-18	-12
1905	-17	-13
1920	-17	-13
1935	-16	-13
1950	-16	-13
1965	-15	-13
1980	-15	-13
1995	-15	-13
2010	-14	-13
2025	-14	-13
2040	-13	-14
2055	-13	-14
2070	-13	-14
2085	-13	-14
2100	-13	-14
2115	-12	-14
2130	-12	-14
2145	-12	-15
2160	-12	-15
2175	-12	-15
2190	-12	-15
2205	-12	-15
2220	-12	-15
2235	-11	-16
2250	-11	-16
2265	-11	-16
2280	-11	-16
2295	-11	-16
2310	-11	-17
2325	-11	-17
2340	-12	-17
2355	-12	-17
2370	-12	-17
2385	-12	-18
2400	-12	-18
2415	-12	-18
2430	-12	-18
2445	-12	-19
2460	-12	-19
2475	-12	-19
2490	-12	-19
2505	-13	-20
2520	-13	-20
2535	-13	-20
2550	-13	-20
2565	-13	-21
2580	-13	-21
2595	-14	-22
2610	-14	-22
2625	-14	-22
2640	-14	-23
2655	-14	-24
2670	-15	-24
2685	-15	-25
2700	-15	-25
2715	-16	-26
2730	-16	-27
2745	-16	-28
2760	-17	-28
2775	-17	-29
2790	-18	-28
2805	-18	-28
2820	-19	-27

Freq. (MHz)	Input VSWR (dBRL)	Output VSWR (dBRL)
2835	-19	-26
2850	-20	-25
2865	-20	-24
2880	-21	-23
2895	-21	-22
2910	-22	-21
2925	-22	-20
2940	-22	-19
2955	-22	-18
2970	-22	-18
2985	-21	-17
3000	-21	-16



100 Davids Drive, Hauppauge, NY 11788
 TEL.: (631) 439-9220 • FAX: (631) 436-7430
 e-mail: components@miteq.com • www.miteq.com

MITEQ AM-1604 SERIES AMPLIFIER

Freq. (MHz)	Reverse Isolation (dB)
5	-65
15	-62
30	-61
45	-61
60	-61
75	-60
90	-61
105	-61
120	-60
135	-60
150	-60
165	-60
180	-61
195	-60
210	-61
225	-61
240	-61
255	-61
270	-61
285	-61
300	-61
315	-61
330	-61
345	-61
360	-61
375	-61
390	-61
405	-61
420	-61
435	-61
450	-60
465	-61
480	-61
495	-61
510	-61
525	-61
540	-61
555	-61
570	-61
585	-61
600	-60
615	-60
630	-60
645	-60
660	-60
675	-60
690	-60
705	-60
720	-60
735	-60
750	-60
765	-60
780	-60
795	-60
810	-60
825	-60

Freq. (MHz)	Reverse Isolation (dB)
840	-60
855	-60
870	-60
885	-60
900	-60
915	-60
930	-60
945	-60
960	-60
975	-60
990	-60
1005	-60
1020	-60
1035	-60
1050	-60
1065	-60
1080	-60
1095	-60
1110	-60
1125	-60
1140	-60
1155	-60
1170	-60
1185	-60
1200	-59
1215	-59
1230	-59
1245	-59
1260	-59
1275	-59
1290	-59
1305	-59
1320	-59
1335	-59
1350	-59
1365	-59
1380	-59
1395	-59
1410	-59
1425	-59
1440	-59
1455	-58
1470	-58
1485	-58
1500	-58
1515	-58
1530	-58
1545	-58
1560	-58
1575	-58
1590	-58
1605	-58
1620	-58
1635	-58
1650	-58
1665	-58

Freq. (MHz)	Reverse Isolation (dB)
1680	-58
1695	-58
1710	-58
1725	-58
1740	-58
1755	-58
1770	-58
1785	-58
1800	-57
1815	-57
1830	-57
1845	-57
1860	-57
1875	-57
1890	-57
1905	-57
1920	-57
1935	-57
1950	-57
1965	-57
1980	-57
1995	-57
2010	-56
2025	-56
2040	-56
2055	-56
2070	-56
2085	-56
2100	-56
2115	-56
2130	-56
2145	-56
2160	-56
2175	-56
2190	-56
2205	-56
2220	-56
2235	-56
2250	-56
2265	-56
2280	-56
2295	-56
2310	-56
2325	-55
2340	-55
2355	-55
2370	-55
2385	-55
2400	-55
2415	-55
2430	-55
2445	-55
2460	-55
2475	-55
2490	-55
2505	-55

Freq. (MHz)	Reverse Isolation (dB)
2520	-55
2535	-55
2550	-55
2565	-55
2580	-55
2595	-55
2610	-55
2625	-55
2640	-55
2655	-54
2670	-54
2685	-54
2700	-54
2715	-54
2730	-54
2745	-54
2760	-54
2775	-54
2790	-54
2805	-54
2820	-54
2835	-54
2850	-54
2865	-54
2880	-54
2895	-54
2910	-54
2925	-54
2940	-54
2955	-54
2970	-54
2985	-54
3000	-54



100 Davids Drive, Hauppauge, NY 11788
 TEL.: (631) 439-9220 • FAX: (631) 436-7430
 e-mail: components@miteq.com • www.miteq.com

MITEQ AM-1604 SERIES AMPLIFIER

OUTLINE	DIM A	DIM B	OUNCES
3	2.74 [69.60]	2.54 [64.52]	2.9

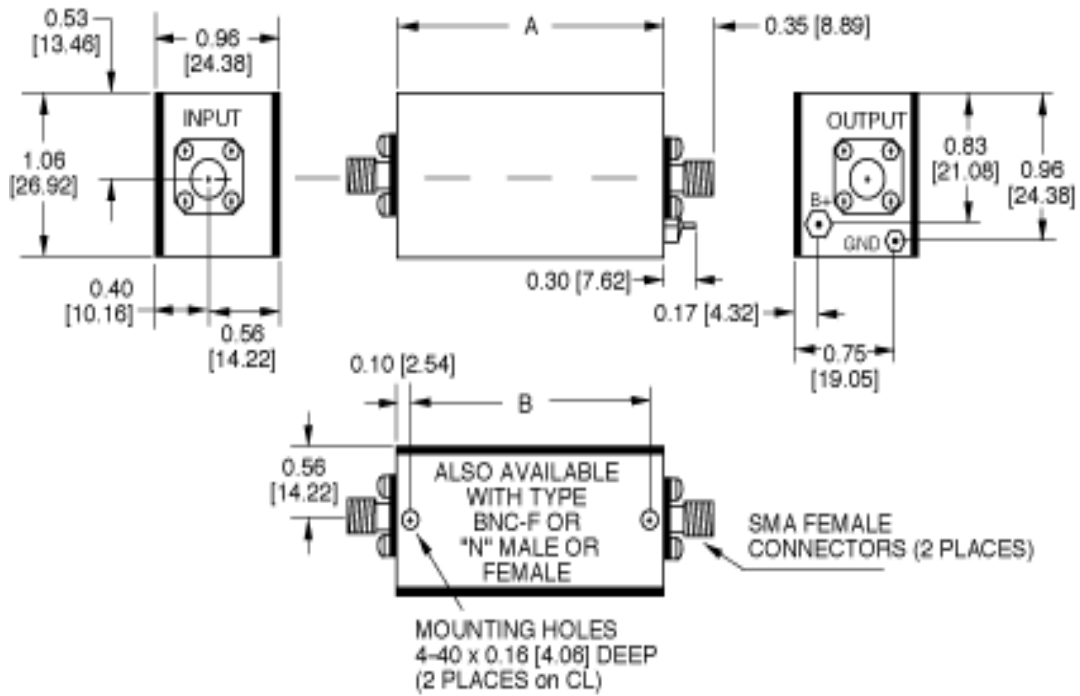

NOTE: DIMENSIONS ARE IN INCHES [MILLIMETERS].

OPTIONS FOR BIPOLAR AMPLIFIERS

INPUT BIAS TEE

Add Suffix "-F"

Used to inject bias signal to photo diode or other type of device. Check for availability on your model before ordering. Available on most units operating above 1 MHz. Please contact MITEQ with your custom requirements.

BIAS THROUGH THE OUTPUT CONNECTOR

Add Suffix "-1306/E" or "-1306/D"

Used to supply operating power when the amplifier is remotely located while eliminating the need to run a separate DC line. Specify whether existing power pin should be "Enabled" or "Disabled." To order, add -1306/E or -1306/D after model number. Example: AU-2A-0150-1306/E will have existing +15 V pin enabled so that it can be used as a test point. Use caution with this option since any voltage applied here will also be present on the RF output center pin. Available on most units operating above 1 MHz.

BIAS THROUGH THE OUTPUT CONNECTOR WITH DC FEEDTHROUGH TO RF INPUT

Add Suffix "-1334/E" or "-1334/D"

Used to supply operating power when the amplifier is remotely located and eliminates the need to run a separate DC line. This DC voltage is then internally fed to the RF input to power a remote LNA or other low power equipment. Maximum current of external load will vary with model type. Available on most units operating above 1 MHz. Please contact factory prior to ordering.

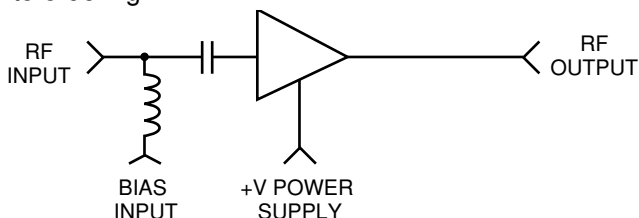

Specify whether existing power pin should be "Enabled" or "Disabled". To order, add "-1334/E" or "-1334/D"

after model number. Example: AU-2A-0150-1334/E will have existing +15 V pin enabled so that it can be used as a test point. Use caution with this option since any voltage applied here will also be present on both the RF output and input center pins.

TYPE N OR BNC CONNECTORS

Add Suffix "-N" or "-BNC"

Type N-female and type BNC-female are available for all outlines 1 through 5, 12, 13 and 15 amplifiers. Add connector type after model number. Examples: AU-2A-0150-N; AU-2A-0150-BNC. Type N-male and mixed connector types are also available on request. Please call MITEQ with your specific requirements.

INPUT INTERNAL LIMITER

Add Suffix "-1103"

Available on models up to 500 MHz. Will protect the input stage from CW signals as high as +30 dBm. To order, add "-1103" after model number. Example: AU-2A-0150-1103. Options are available for protection against short duration pulses up to 50 W.

AC POWER SUPPLY (100 to 240 VAC, 47 - 440 Hz). Add Suffix "-1179"

Available as an add-on to most models using outlines 1 through 5 and 15. Includes 6-foot line cord with standard US line plug, internal fuse, on/off switch and LED indicator light. Amplifier is permanently mounted to power supply. To order, add "-1179" after model number. Example: AU-2A-0150-1179. Refer to outline 12 for dimensions.

AC POWER SUPPLY (Wall plug-in unit) Part Number "205531-19"

A low cost alternate to option "-1179", the wall plug-in unit is a small switching power supply capable of delivering 1 amp at 15 volts.

AC POWER SUPPLY WITH SMC CONNECTORS (Wall plug-in unit) Part Number "-1179SC"

Same as above except has mating SMC connectors on amplifier DC input and power supply DC output. Available for outlines 1 through 10, 13 and 15.

ADDITIONAL OPTIONS AVAILABLE

OPTION	SUFFIX
Gain Window	-GW
Phase Match	-PM
Amplitude Match	-AM
Gain Control	-GC



100 Davids Drive, Hauppauge, NY 11788
TEL.: (631) 439-9220 • FAX: (631) 436-7430
e-mail: components@miteq.com • www.miteq.com

GENERAL INFORMATION

PRICING AND TERMS

A quotation on any item in the catalog is available by contacting the factory. All quotations, unless otherwise noted, are valid for 60 days from the date of issue, F.O.B. (FCA) Hauppauge, NY 11788. Pricing does not include customer or government source inspection unless otherwise noted. On international orders, an irrevocable letter of credit may be required. MITEQ accepts these credit cards:

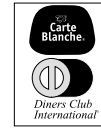

QUANTITY DISCOUNTS

A quantity discount is generally available on most catalog items. Due to the wide variety of devices in the catalog, it is not possible to provide a standard discount schedule. When quantities are involved, please contact the factory and the appropriate information will be provided.

SOURCE INSPECTION

Government / customer source inspection is available on any item upon receipt of the complete written confirmation of purchase order items, including the prime government contract number. Source inspection with respect to some products increases the unit price and extends delivery because of duplicate standard final inspection and testing. It is recommended wherever possible that a Certificate of Compliance be substituted for source inspection to minimize price and delivery delays.

SHIPPING INFORMATION

Unless instructed otherwise by the customer, we will ship UPS in the U.S. F.O.B. (FCA) Hauppauge. Air freight will be used as the primary international means of shipment. Please indicate at time of purchase what method of shipment you require.

RETURNED MATERIAL

When returning material for repair or replacement, please ensure that there is complete information included with the shipment, giving a detailed description of the reason for its return, the date and purchase order on which it was obtained, and the exact address to which the material is to be reshipped. All returns must arrive freight, postage, duties and handling prepaid.

REPAIR COSTS

Warranty repairs will be made at no cost to the customer. Units out of warranty, or those which have been mishandled, will require approval by the customer for the charges involved before the repairs can be accomplished. We will provide an estimate for the cost of the repair, which can be applied to the repair, if approval is granted. For those items that are deemed beyond repair, or where the customer may decide not to repair the unit, an evaluation fee and handling charge will be applicable.

APPLICATION ENGINEERING

We maintain a large support staff of engineers who are experts in specific areas of microwave technology. Each has an engineering background that combines both a formal engineering education with training and experience in product design. As further technical support, we make available the services of our engineering and scientific staff, who may be consulted on more advanced circuit designs or application problems.

DRAWINGS AND SPECIFICATIONS

The material presented in this catalog was current at the time of publication. MITEQ Inc.'s continuing product improvement program makes it necessary to reserve the right to change our mechanical and electrical specifications without notice. If either of these parameters is critical, please contact the factory to verify that the information is current.

ADDITIONAL INFORMATION

WARRANTY

ISO 9001:2000 Certified



MITEQ FEDERAL SUPPLY CODE

Our Federal Supply Code is: 33592



100 Davids Drive, Hauppauge, NY 11788
TEL.: (631) 439-9220 • FAX: (631) 436-7430
e-mail: components@miteq.com • www.miteq.com